

Installation Manual

JV-1FD (Hands free color video intercom expansion monitor station)

To installers:

- After installation is completed, be sure to hand the accessories to the customer.

NOTE:

- The illustrations and images used in this manual may differ from the actual ones.

HTML manual



https://www.aip-info.net/file/manual/j/JV-1FD/JV-1FD_INS/JV-1FD_INS_EN/content/

Table of contents

Package contents	2
Precautions	2
Part names and functions	3
Wiring	4
Precautions for wiring	4
Wiring diagram and specifications	6
Precautions for installation	8
Mounting	8
After installation	10
Check after installation	10
Installer settings	11
Privacy notice	12



Package contents

- JV-1FD (expansion monitor station)
- Installation manual
- Information sheet
- Contact us sheet
- Chinese RoHS declaration

NOTE







- Mounting screws and wood screws are not included.

Precautions

-  Indicates that users may require caution (including warning / caution).
-  Alerts users to prohibited actions.
-  Restricts user actions / provides instructions.





WARNING

Negligence could result in death or serious injury.

-  **This product is not designed to explosion-proof specifications. Do not install or use in locations that can contain flammable gases.**
This may result in fire or explosion.
-  **Do not disassemble or modify the station.**
This may result in fire or electrical shock.
-  **Do not use with a power supply rated above the specified voltage.**
This may result in fire or electrical shock.
-  **Do not use the power supply other than Aiphone specified.**
This may result in fire or malfunction.
-  **Do not install two power supplies in parallel to a single input.**
This may result in fire or electrical shock.
-  **Do not connect any terminals on the product directly to an AC power line.**
This may result in fire or electrical shock.

CAUTION

Negligence could result in injury to people or damage to property.

-  **Do not install or connect the product with the power on.**
This may result in electrical shock or malfunction.
-  **Make sure the wiring is correct and there are no wiring shorts before switching on the product.**
This may result in fire or electrical shock.
-  **Install in a place where the product will not get easily bumped.**
This may result in injury.
-  **Do not put your ear close to the speaker when using the product.**
May cause harm to the ear if a sudden loud noise is emitted.

General Precautions

- Install low-voltage lines at least 30 cm (12") away from high-voltage lines (AC 100V-240 V), especially inverter air conditioner wiring. This may result in interference or malfunction.
- When installing or using the station, give consideration to the privacy rights of subjects, as it is the responsibility of the system owner to post signs or warnings in accordance with local ordinances.
- Keep the unit more than 1 m (3.3') away from radio or TV set.

Notice

- If the station is used in areas where there are business-use wireless devices such as a transceiver or mobile phones, it may cause malfunction.
- Keep the intercom wires more than 30 cm (12") away from AC 100-240 V wiring. AC induced noise and/or unit malfunction could result.
- If the station is installed in an area with an extremely strong electrical field, such as in the vicinity of a broadcasting station, it may create interference and cause a malfunction.

Part names and functions

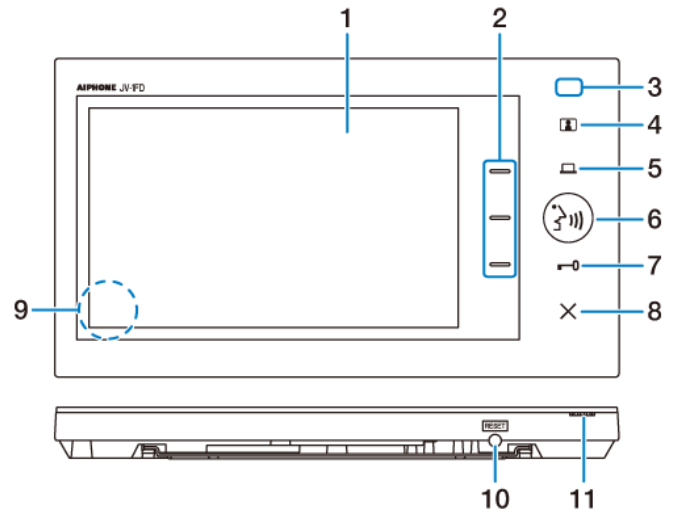

Expansion monitor station (JV-1FD)



No.	Item	Description
1	Color LCD screen	Color LCD screen doesn't have touch interface.
2	Function buttons	<ul style="list-style-type: none"> • Tap the corresponding function button to execute the function displayed on the right side of the screen. • Tap any function button in standby mode to display the settings menu.
3	Notification LED (blue)	Indicates the current status of the station. → Notification LED (P.4)
4	Monitor button	Tap the monitor button to monitor the outside of the door.
5	Option button	Tap the option button to activate a connected external device.
6	Talk button	Tap the talk button to start communication.
7	Door release button	Tap the door release button to unlock the electric lock at the door station.
8	End button	Tap the end button to exit the current operation and enter standby mode.
9	Speaker	The speaker is on the back side of the station.
10	RESET switch	Push the RESET switch to reboot the station when it is not responding. Even if you reboot the station, the settings and recorded image are retained.
11	Microphone	Do not block the microphone with stickers or tape. Otherwise, communication may not be possible.

Notification LED

Refer to the "Operation Manual" for other indicators not listed.

LED		Description
Blue light	On	<ul style="list-style-type: none"> Blue LED is lighting during startup. Blue LED is lighting when the ringtone volume is set to "0". Blue LED is lighting when talk direction is monitor station to door station.
Blue flashing	On (0.25 sec.) ↑↓ Off (0.25 sec.)	When a short circuit is detected in the door station wiring.
	On (0.5 sec.) ↑↓ Off (0.5 sec.) The LED turns off after flashing 3 times.	<ul style="list-style-type: none"> Blue LED is flashing when you tap  to unlock the electric lock. Blue LED is flashing when you tap  to activate the external unit.

Wiring

Precautions for wiring

Cable

- Use a parallel 2-conductor wiring cable for connection of a video door station and master monitor station.
- Select a PE (polyethylene)-insulated PVC jacket cable for low voltage wiring.
 - A coaxial cable cannot be used.
 - A 2-pair quad-type vinyl sheathed cable cannot be used.
- For wiring, separate them for audio/video and door release and keep them more than 10 cm (3-15/16") away from each other.
- If existing wiring is used, the device may not operate properly. In that case, it will be necessary to replace the wiring.
- When using existing cables, check for short circuit and disconnection before installation.

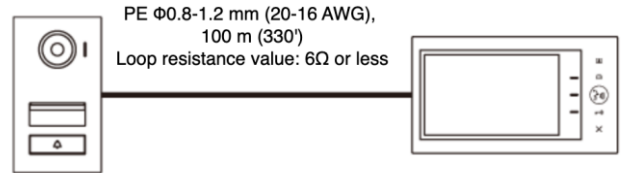

- Disconnection check (6Ω or less)
Connect the ends of one side and make a measure at the other side with a tester.

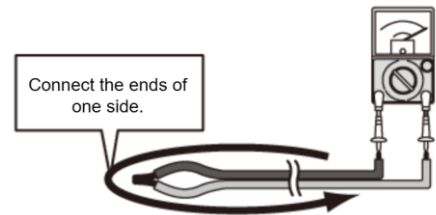

- Short circuit check: ∞Ω (Infinity)

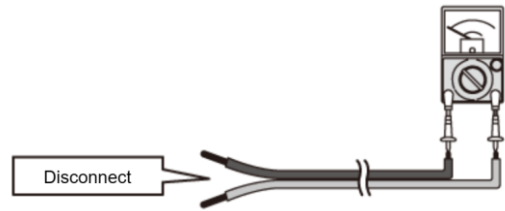

- To connect low voltage wires, either crimp them with a crimp sleeve or solder them, and then insulate by covering with insulating tape.

How to connect low voltage wires each other

Crimping with a crimp sleeve

- 1 Twist the stranded conductor around the solid conductor at least three times, then crimp them.

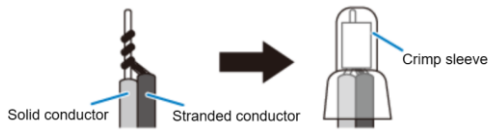

- 2 Overlap more than half of the width and twist them at least twice.



Soldering

- 1 Twist the stranded conductor around the solid conductor at least three times.

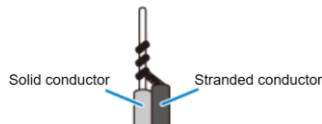

- 2 Bend the tip and solder it. Make sure no lead wire sticks out.

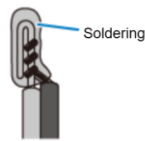

- 3 Overlap more than half of the width and twist them at least twice.

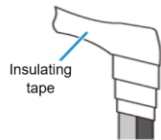

ATTENTION

- When crimping with a crimp sleeve, if the tip of the lead wire with connector is soldered, cut off the soldered part before crimping it.
- **After connecting wires, always check for breaking or insufficient connection. Especially when connecting a wire in the middle of wiring, either crimp it with a crimp sleeve or solder it, and then insulate it by covering with insulating tape. Keep the number of connections as low as possible when wiring.** Just twisting wires may cause poor connection, or the surface of the wires may get oxidized and cause a loose connection, leading to malfunctioning or failure.



Wiring diagram and specifications

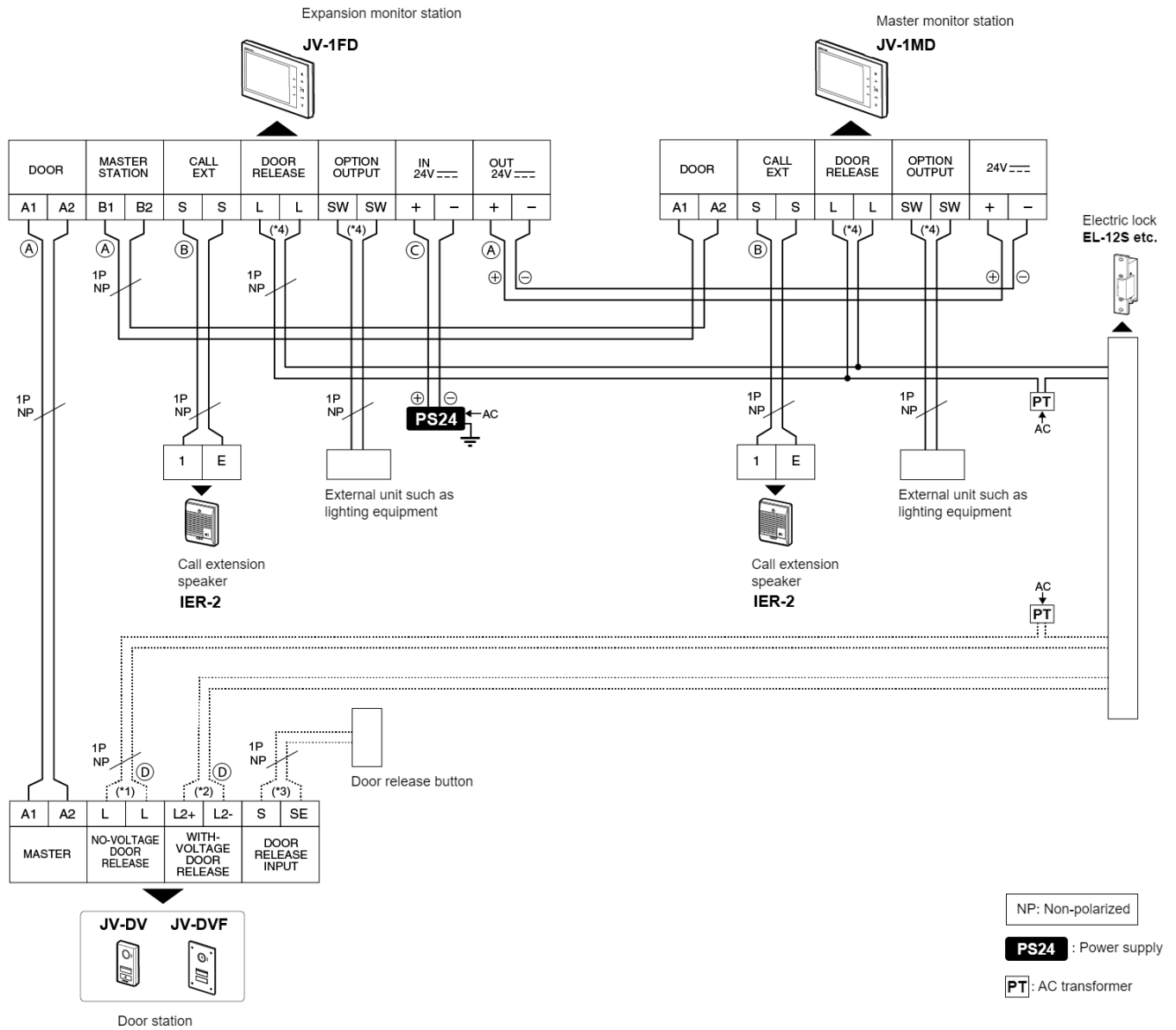

ATTENTION

- Do not use the unused terminals for other purposes.
- The wiring between each device should not be in the same sheath wiring. (However, the wirings between the expansion monitor station and the master monitor station, and between the expansion monitor station and 24 V DC +/- can be made in the same sheath. All other wirings should be kept at least 10 cm (3-15/16") away from the A1/A2 and power +/- wirings.)
- Insulate and secure unused low-voltage lines.
- Only connect an electric lock to a single location.
- The external door release button activates only electric lock which is connected to door station.
- Be sure to ground the power supply.
- Wiring connections be made between the door station and the expansion monitor station, and between the expansion monitor station and the master monitor station.
- Be sure to supply power to the master monitor station from a single power supply via the expansion monitor station.

NOTE

- The sequence of terminals in the diagram may differ from the actual product.
- Also refer to the instructions for each device to be connected.

Wiring distance

(A)	PE Φ 0.65 mm (22 AWG): 50 m (165') PE Φ 0.8-1.2 mm (20-16 AWG): 100 m (330')
(B)	PE Φ 0.65 mm (22 AWG): 50 m (165') PE Φ 0.8-1.2 mm (20-16 AWG): 150 m (490')
(C)	PE Φ 0.65 mm (22 AWG): 5 m (16'5") PE Φ 0.8 mm (20 AWG): 10 m (33')
(D)	PE Φ 0.65 mm (22 AWG): 15 m (49') PE Φ 0.8-1.2 mm (20-16 AWG): 30 m (98'5")
Others	PE Φ 0.65-1.2 mm (22-16 AWG)

NOTE

- The wiring distance between the expansion monitor station and the power supply can be extended up to 25 m (82') by using a PE Φ 1.2 mm (16 AWG) cable. However, the maximum distances between the door station and the expansion monitor station, and between the expansion monitor station and the master monitor station will be shortened to 70 m (230') by using a PE Φ 0.8-1.2 mm (20-16 AWG) cable.
- When the wet contact output from the door station is 12 VDC, 580 mA (higher than 500 mA, 580 mA or lower), the wiring distances between the door station and the expansion monitor station, and between the master monitor station and the expansion monitor station should be 70 m (230') or shorter by using a PE Φ 0.8-1.2 mm (20-16 AWG) cable.

(*1): Output specifications

Output method	Dry contact (N/O)
Contact rating	24 VDC, 1 A (resistive load)

(*2): Output specifications

Output method	Wet contact (N/O)
Output current	500 mA or less
Output voltage	12 VDC

(*3): Input specifications

Input method	Dry contact (N/O)
Detection time	100 msec or more
Contact resistance	300 Ω or less
Terminal short-circuit current	10 mA or less
Voltage between terminals	5 VDC or less (between open terminals)

(*4): Output specifications

Output method	Dry contact (N/O)
Contact rating	24 VDC, 1 A (resistive load)

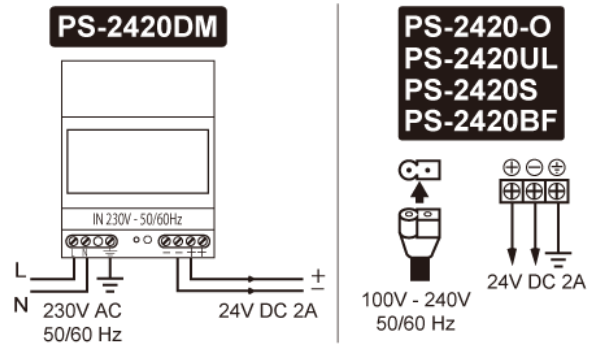

Precautions for installation

- This unit is designed for indoor use only. Do not install at outdoor location.
- Installing the device in the following locations could cause malfunction:
 - * **Locations under direct sunlight**
 - * **Locations near heating equipment**
 - * **Locations subject to liquid, iron filings, dust, oil, or chemicals**
 - * **Locations subject to moisture and humidity extremes**
 - * **Locations where the temperature is quite low**
 - * **Locations subject to steam or oil smoke**
 - * **Sulphurous environments**
 - * **Locations close to the sea or directly exposed to sea breeze**
- The installation height of the station should not exceed 2 m (6.6') (upper edge) from ground level.
- Do not use an impact driver to fasten screws. Doing so may cause damage to the device.
- Always properly secure wall mounted stations to prevent the station from falling.

Mounting

ATTENTION

- Do not embed the station inside a wall.
- To prevent malfunction, install the station at least 20 cm (8") away from other devices (e.g., floor heating remote control).
- Avoid installing the station in a concave space in a wall to prevent audio distortion.
- The location of the station requires the following open spaces to prevent malfunctions or call interruption.
 - 15 cm (6") or more above the center of the station.
 - 25 cm (10") or more below the center of the station (to allow operation of the reset button on the bottom of the station).
 - 5 cm (2") or more on the left side of the station (to avoid blocking the speaker).

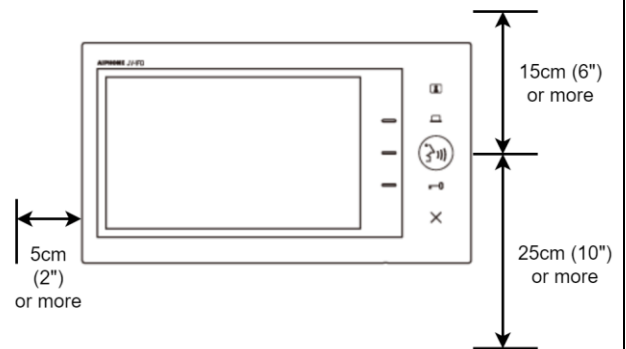

Back wiring

Installation video

https://www.aip-info.net/file/manual/j/JV-1FD/JV-1FD_INS/JV-1FD_INS_EN/content/attachments/101967499/101968942.mp4



- 1 Remove the mounting bracket [A] from the back of the station.**
Slide the mounting bracket down, and remove it.

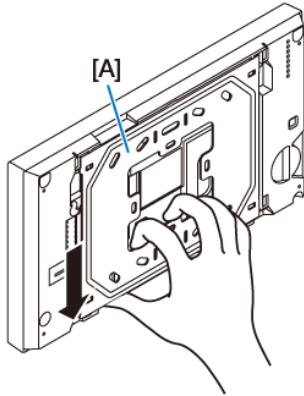

- 2 Fasten the mounting bracket to the wall with the screws [B] (×2).**
When using a 3-gang box, use screws [C] (×4).

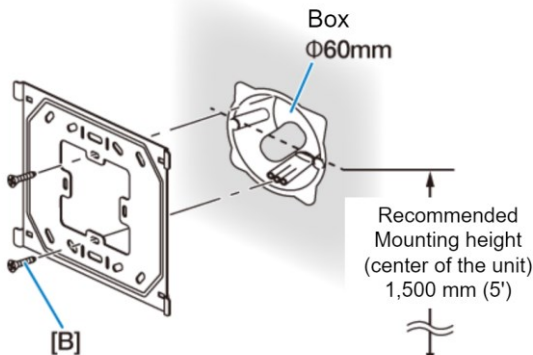

or

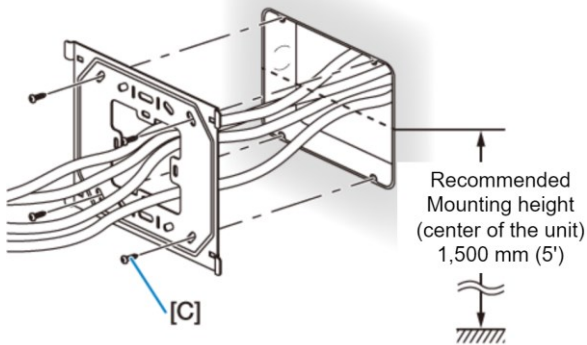

- 3 Connect wires.**
Strip 8 mm (5/16") of the wire jacket and insert it into the terminal. If it is difficult to insert, press and hold the release button [D] while inserting.

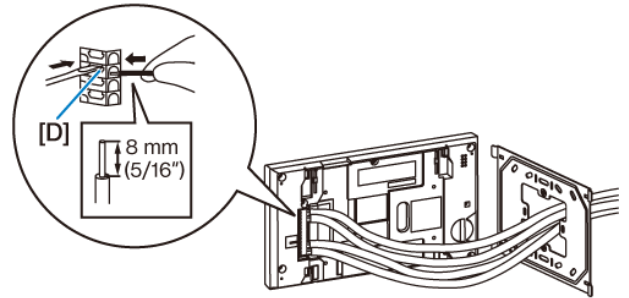

- 4 Mount the station on the mounting bracket [A].**

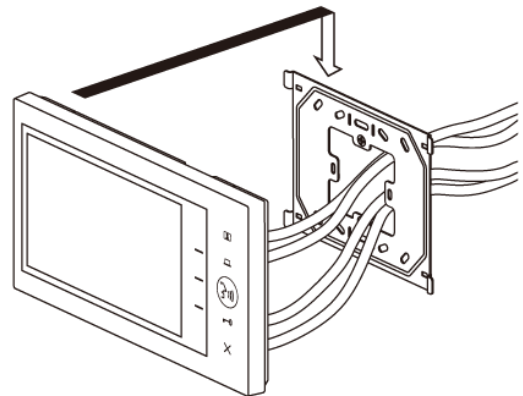

ATTENTION

- Be careful not to trap cables between the station and the mounting bracket.
- Be careful not to damage the cable sheath with the mounting bracket.

NOTE

- When using wood mounting screws (×4) for wall mounting, drill a 50 mm (1-15/16") diameter hole at the position of the station's center on the wall.

Available screws

[B]	Should be compatible with a gang box.
[C]	Screw shaft: $\Phi 4.1$ mm or less Slotted head: $\Phi 8.2$ mm or less, 3.0 mm or less in height
Wood mounting screw	Screw shaft: $\Phi 4.1$ mm or less Slotted head: $\Phi 8.2$ mm or less, 3.0 mm or less in height

Surface wiring

The wires can be routed to the top or bottom of the station. If wiring is to be routed from the top of the station, cut the cable inlet [E].

If there is a large amount of wiring [F], strip away the jacket of the wire up to the cable inlet.

Fasten the mounting bracket to the wall with wood mounting screws [G] (×4).

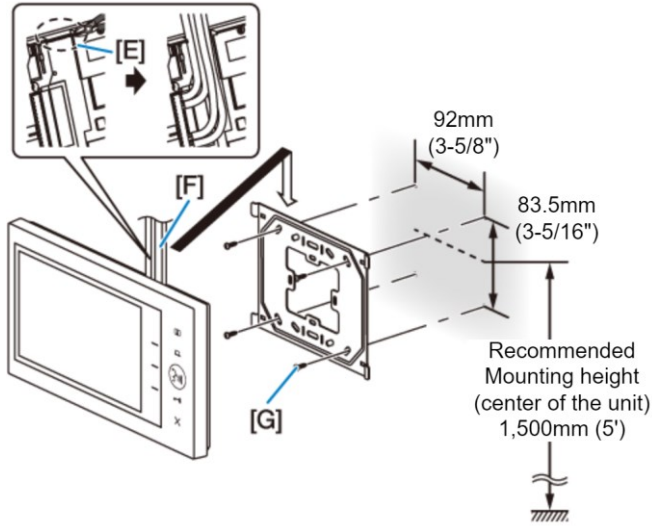

Available screws

[G]	Screw shaft: $\Phi 4.1$ mm or less Slotted head: $\Phi 8.2$ mm or less, 3.0 mm or less in height
-----	---

NOTE

- When wood mounting screws cannot be used for plasterboard walls, concrete walls, and the like, use commercially-available board anchors [H] or concrete plugs [I].

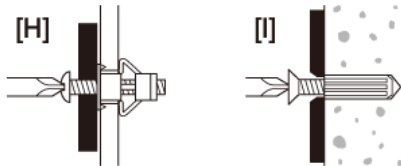

After installation

Check after installation

After installation, check that the system is functioning in accordance with the operation manual.

If not operating properly

Remove the door station, and then connect it directly to the station with short, low-voltage wires to check its operation.

If it operates properly, there may be a problem with the wiring. Check the wiring connections.

CAUTION

- Be sure to unplug the power supply before removing the low voltage wires.

When the notification LED flashes

The wiring to the door station may be shorted. Check the wiring.

The station will restart when the short circuit is restored.

For more information on the notification LED, refer to "[Notification LED \(P.4\)](#)."

Installer settings

ATTENTION

- Be sure to configure the settings according to the connected devices. Otherwise, the station may not operate properly.

NOTE

- While in the settings menu, no operations such as calls or notifications can be performed.
- The station will enter standby mode (the display will turn off) after about one minute of no operation. If this occurs, any unfinished setting changes will be lost.

Installer setting items

No.	Item	Details	Setting value ([]: Default)
1	Contact output time (*)		
	Option output duration	Sets the option output duration time.	1/[5]/10/20/30 (sec)
	Door release duration	Sets the unlocking duration for the electric door lock.	1/[5]/10/20/30 (sec)
2	Initialize	Resets all settings to default.	-

(*): The setting values should be the same as those of other monitor station.

Installer setup menu screen

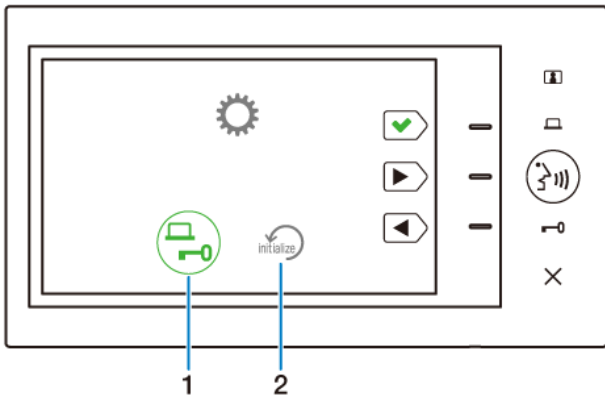

Setting procedure (e.g., setting the door release duration)

- 1 Tap one of the function buttons in standby mode. The menu screen will be shown.



- 2 Tap and hold the person icon for 5 seconds or more. The installer setup menu screen will be shown.

- 3 Tap the function button (right arrow) or (left arrow) to select the door lock icon, then tap the function button (green checkmark). The contact output time screen will be shown.

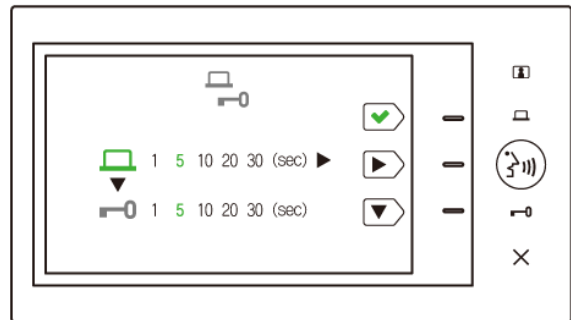

- 4 Tap the function button (down arrow) to select the door lock icon.
- 5 Tap the function button (right arrow) to adjust the door release duration.
- 6 Tap the function button (green checkmark) to apply changes.

ATTENTION

- Be sure to tap the function button (green checkmark) to apply changes.
- Changes will not be applied if the close button (X) is pressed.

Privacy notice

<https://www.aip-info.net/legal/privacy/>

